

Table of Content 87031082USL

1. User manual	2
2. Legal regulations	2
3. Safety instructions	3
4. Settings	4
5. Functional principle	5
6. Technical data	6
7. Performance graph	7
8. Mounting	8
9. Condensate management	9
10. Mounting Principle	10
11. Cut out dimensions	11
12. Dimensions (H x W x D)	12
13. Electrical connection	13
14. Controller	14
15. Wiring diagram	18
16. Taking into operation	19
17. Trouble shooting	19
18. Maintenance & Cleaning	20
19. Transport & Storage	21
20. Parts supplied / Spare parts / Accessories	22



1. User manual

This instruction manual contains information and instructions to enable the user to work safely, correctly and economically on the unit. Understanding and adhering to the manual can help one:

- Avoid any dangers.
- Reduce repair costs and stoppages.
- Extend and improve the reliability and working life of the unit.

PLEASE ENSURE TO USE THE RIGHT VERSION OF THE INSTRUCTION MANUAL SUITABLE FOR YOUR UNIT.

Intended use

The unit is to be used exclusively for the dissipation of heat from control cabinets and enclosures in order to protect temperature sensitive components in an industrial environment. To meet the conditions of use, all the information and instructions in the instruction manual must be adhered to.



General danger

Indicates compulsory safety regulations which are not covered by a specific pictogram such as one of the following.



High electric voltage

Indicates electric shock danger.



Important safety instruction

Indicates instructions for safe maintenance and operation of the unit.



Attention

Indicates possible burns from hot components.



Attention

Indicates possible damage to the unit.



Instruction

Indicates possible danger to the environment.

2. Legal regulations

Liability

The information, data and instructions contained in this instruction manual are current at the time of going to press. We reserve the right to make technical changes to the unit in the course of its development. Therefore, no claims can be accepted for previously delivered units based on the information, diagrams or descriptions contained in this manual. No liability can be accepted for damage and production caused by:

- Disregarding the instruction manual
- Operating error
- Inappropriate work on or with the unit
- The use of non-specified spare parts and accessories
- Unauthorised modifications or changes to the unit by the user or his personnel

The supplier is only liable for errors and omissions as outlined in the guarantee conditions contained in the main contractual agreement. Claims for damages on any grounds are excluded.

3. Safety instructions

Upon delivery the unit is already meeting current technical standards and can therefore be safely taken into operation. Only authorised personnel is allowed to work on the unit. Unauthorised personnel must be prohibited from working on the unit. Operating personnel must inform their superiors immediately of any malfunction of the unit.

Please note that before starting to work on or with the unit, a procedure must be carried out inside the cabinet on which the unit is to be mounted.

Before commencing work inside the cabinet, the control cabinet manufacturer's instruction must be read with regards to:

- Safety instructions.
- Instructions on taking the cabinet out of operation.
- Instructions on the prevention of unauthorised cabinet reconnection.

The electric equipment meets the valid safety regulations. One can find dangerous voltages (above 50 V AC or above 100 V DC)

- Behind the control cabinet doors.
- On the power supply in the unit housing.

The unit has to be operated according to the type plate and the wiring diagram, and must be protected externally from overloading and electrical faults via suitable protective devices.



Danger through incorrect work on the unit

The unit can only be installed and maintained by technical competent and qualified personnel, using only supplied material according to the supplied instructions.



Danger from electrical voltage

Only specialised personnel are allowed to maintain and clean the unit. The personnel must ensure that for the duration of the maintenance and cleaning, the unit is disconnected from the electrical supply.



Attention

Damage to the unit through the use of inappropriate cleaning materials. Please do not use aggressive cleaning material.



Instruction

Damage to the environment through unauthorised disposal. All spare parts and associated material must be disposed according to the environmental laws.

4. Settings

The cooling unit is intended to be used as a complementary accessory to larger industrial equipment. The unit is used where heat needs to be dissipated from electrical control cabinets or similar enclosures in order to protect heat sensitive components. *It is not intended for household use.*

The unit has two completely separate air circuits which ensure that the clean cabinet air does not come into contact with the ambient air which may well be dirty or polluted.

Enclosure cooling units can dissipate large quantities of heat from sealed enclosures such as electrical enclosures into the ambient air and at the same time reduce the cabinet internal temperature to below that of the ambient air. The unit can function without problems in extreme ambient conditions (e.g. dusty and oily air). For the cooling capacities, operating temperatures and environmental ratings please refer to the type plate data.

5. Functional principle

The cooling unit for enclosures works on the basis of a refrigeration circuit consisting of four main components: compressor, evaporator, condenser and expansion device.

The circuit is hermetically sealed and R134a refrigerant circulates inside it (R134a is chlorine free and has an Ozone Destruction Potential [ODP] of 0 and a Global Warming Potential [GWP] of 1430). The compressor compresses the refrigerant (thus taking it to high pressure and high temperature), and pushes it through the condenser, where it is cooled by ambient air thus passing from the gas to the liquid state. At the liquid state it then passes through the capillary pipe being a much lower pressure the refrigerant arrives to the evaporator where it absorbs the necessary heat to change from liquid to gas state. The gas is then drawn back into the compressor completing the cycle.

- | | |
|---------------------------|---------------------------|
| 1 Air intake cabinet side | 6 Air intake ambient side |
| 2 Radial fan cabinet side | 7 Air intake ambient side |
| 3 Evaporator | 8 Condenser |
| 4 Air outlet cabinet side | 9 Air outlet ambient side |
| 5 Compressor | 10 Filter dryer |
| | 11 Expansion device |



6. Technical data

Order Number	87031082USL
Cooling capacity 95F/95F	1020 BTU
Cooling capacity 95F/122F	631 BTU
EER 95F95F	3.3 BTU/Whr
Compressor type	rotary piston compressor
Refrigerant / GWP	R 134a / 1430
Refrigerant charge	75 g / 2.6 oz
High / low pressure	406 / 88 psi
Operating temperature range	-40°F - 140°F
UL temperature range	-40°F - 131°F
Air volume flow (system / unimpeded)	Ambient: 140 / 240 cfm Cabinet: 70 / 105 cfm
Mounting	Wall mounted
Housing Material	Stainless steel AISI 304 (V2A)
Dimension H x W x D	15 x 9.85 x 9.85 inch
Weight	32 lbs
Voltage / Frequency	120 V ~ 50/60 Hz
UL Voltage / Frequency	120 V ~ 60 Hz
Current 95F95F	2.9 A @ 50 Hz 2.8 A @ 60 Hz
Starting current	7.5 A
Max. current	3.2 A
Nominal power 95F95F	310 W @ 50 Hz 330 W @ 60 Hz
Max. power	380 W
Fuse	15 A (T)
Max circuit ampacity	15 A
Short-circuit current rating	5 kA
Rated current compressor	2.2 A
Full load current fans	0.38 A
Connection	Cable outlet for power/signals
Ingress protection	IP 56 / Type 12, 3, 3R, 4, 4X
Approvals	CE, UL(ACVS), cULus

7. Performance graph

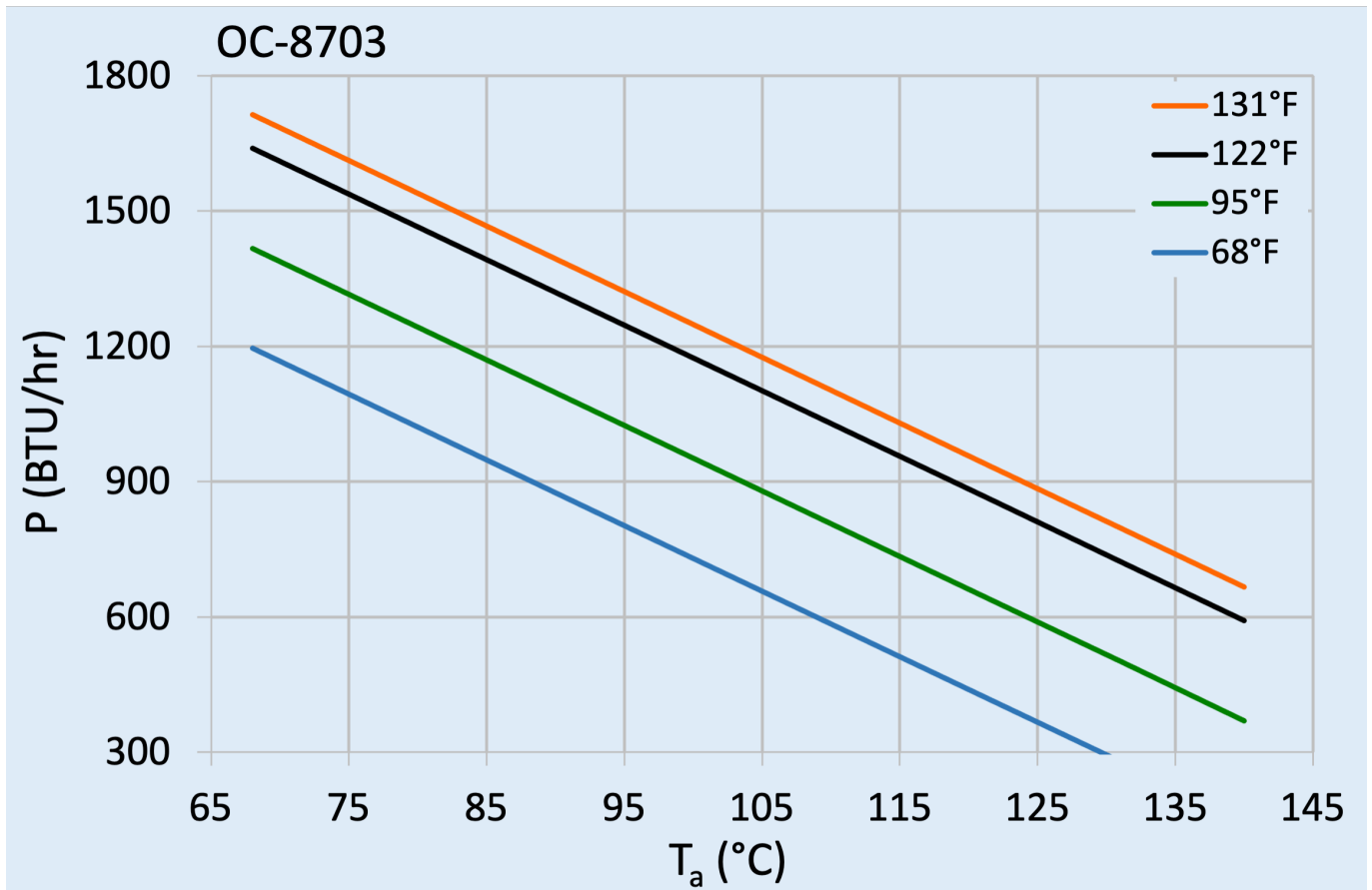

8. Mounting

Unpacking unit:

Please follow the below steps to unpack the unit.

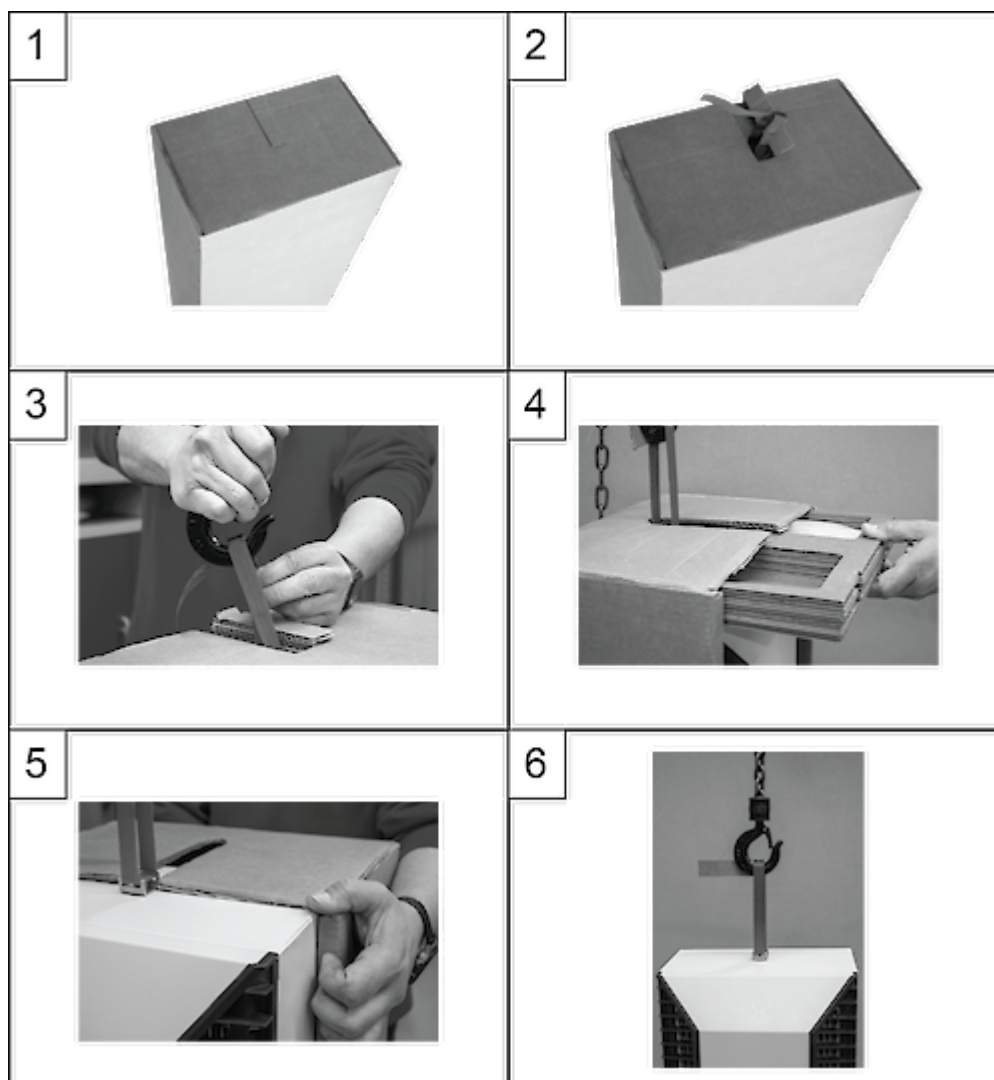

STEP 1:
Stand the air conditioner upright with the pre-cut packaging opening facing up.

STEP 2:
Pull off the packaging opening.

STEP 3:
Hang the transport loop of the unit in the transport hook and lift it slightly.

STEP 4:
Pull off the packaging and slide out the tray with installation material and the short version of the operating manual.

STEP 5:
Pull off the remaining packaging.

STEP 6:
The cooling unit can now be attached to the enclosure.

Mounting:



The power supply rating on unit rating plate must comply with mains rating.



Always disconnect the power supply before opening the unit.

The heat load to be dissipated from enclosure should not exceed specific cooling output of the unit at any condition. At cooling unit selection always cater for a safety margin of at least 15% extra cooling output in the worst conditions. Air inlets and outlets must be completely free from obstruction.

Ensure that flows of air leaving and entering the cooling unit, internal and external, are not obstructed. Cooling unit enclosure air suction hole must be installed in the highest possible point. When installing the unit on a door ensure it can take the weight.

Before drilling the enclosure ensure the fixing elements and couplings will not interfere with the equipment inside the enclosure itself. Disconnect power before starting any work inside the enclosure. Following this 1:1 Scale Drilling Template drill the holes and make the required cuts on the enclosure. This template may have been affected by storage conditions, please check this template by verifying values of the largest dimensions before drilling. Fit the sealing strip on the cooling unit on the side connected to the enclosure and follow the installation diagram.

This AC unit can only be mounted to a suitably Type rated enclosure to maintain it's Type rating. The Type and IP rating of the enclosure should be the same or higher than that of the unit.

9. Condensate management

High humidity and low temperatures inside the enclosure can lead to condensation on the evaporator. Condensate that flows back into the enclosure can damage sensitive control electronics. The integrated condensate evaporation of the cooling unit releases the condensate to the environment. If condensate formation is too great, additional condensate can drip into an overflow trough, which then drains off on the ambient side. In order to prevent the formation of excessive condensate, you should nevertheless:

- check the seals at regular intervals
- consider installing a door contact switch (order no. 3100001). This can prevent condensation forming when enclosure door is left open.

Condensation drain pipe connection:

The condensation drain is in the base of the unit. The condensation drain pipe should be attached as required e.g. in conditions of high humidity.

10. Mounting Principle



NOTES:

Do not use within the first 15 minutes after installation!

Use only the supplied mounting hardware.

Tighten Screws to 4.5 Nm.

Ensure the mounting surface does not warp after assembly and reinforce it if necessary.

- 1 M6 bolts
- 2 M6 toothed washers
- 3 M6 Flat washers
- 4 Enclosure
- 5 Mounting gasket
- 6 Cooling unit

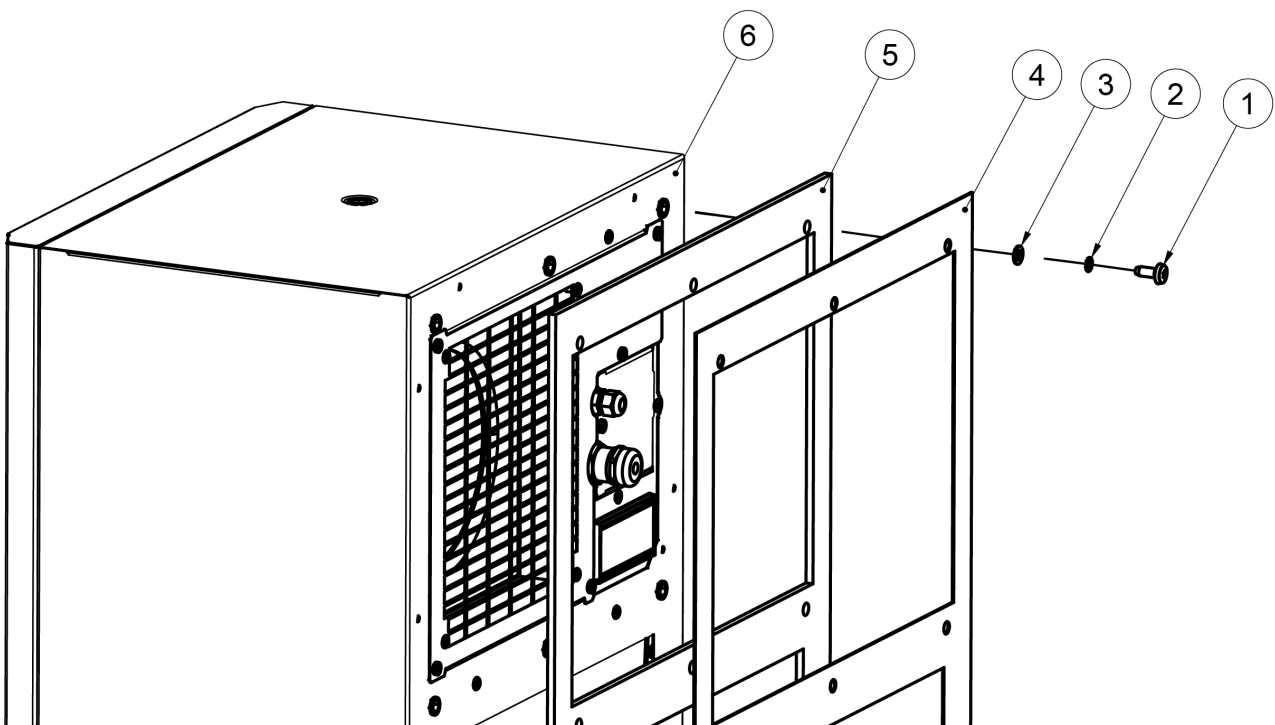

12. Dimensions (H x W x D)

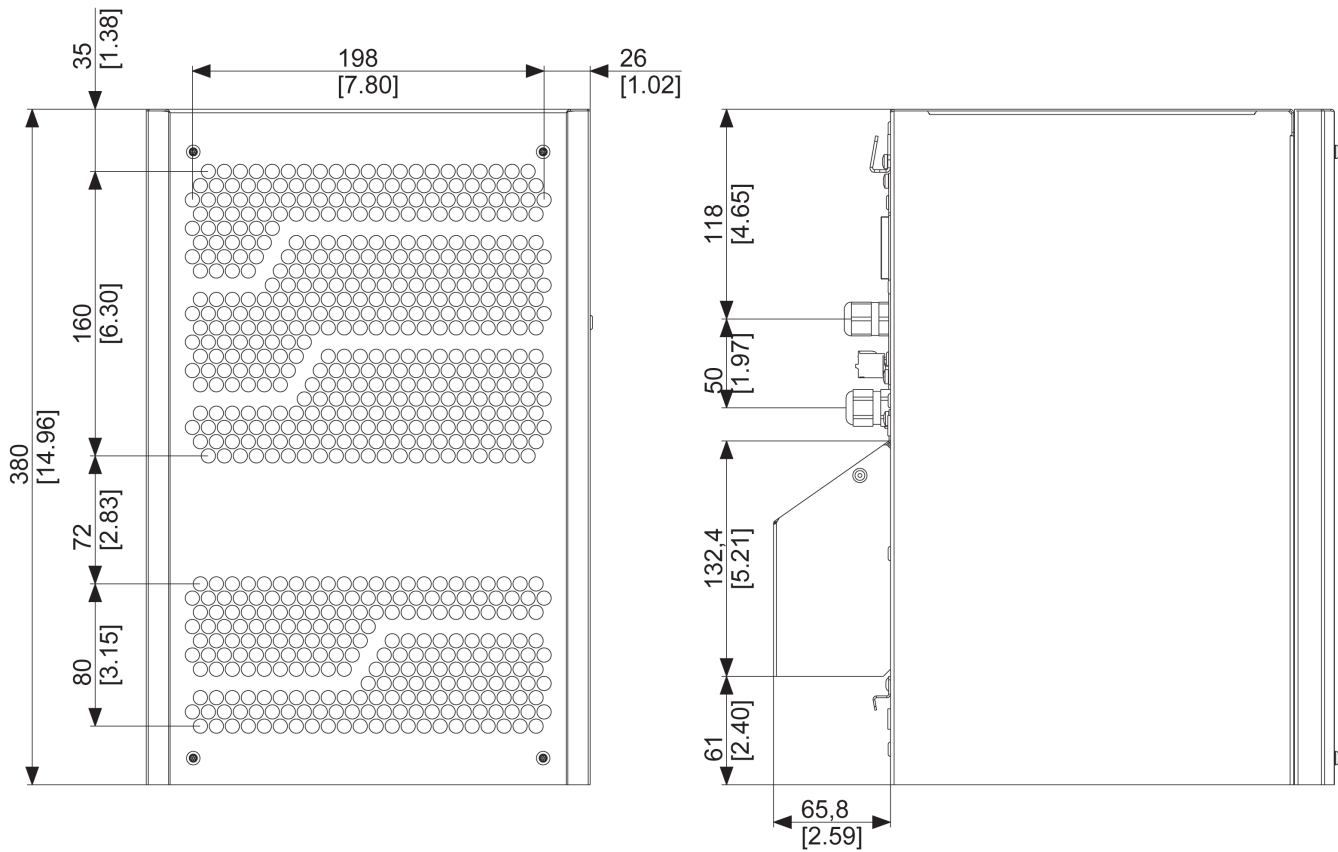

13. Electrical connection

Door Switch

The unit can be switched ON and OFF via a door contact switch. When delivered the door contact terminals are bridged on the female connector. To connect the door contact switch remove the bridge and connect door contact switch. The contact must be closed when the cabinet door is closed.

It is possible to change the logic of the door switch (controller firmware rev. 1.2 or higher). This can be set by changing the value of parameter c68. Refer to the table below and section *Controller: Setting temperature units (°C / °F), low temperature alarm, door contact logic section* for more information.

c68 = 0 (default)	ON if closed - Door contact terminals bridged, or NC door switch connected (contact must be closed when cabinet door is closed)
c68 = 1	ON if open - Remove bridge, or NO door switch connected (contact must be open when cabinet door is closed)

Alarm Contacts

Alarm contacts rated according to:

EN60730-1 8(4)A N.O., 6(4)A N.C., 2(2)A N.O./ N.C. @ 250Vac 100000 cycles
UL 873 8A resistive 2FLA 12LRA, pilot duty C300 @ 250Vac 30000 cycles

These contacts are not suitable for fluorescent loads (neon lights, etc.) that use starters (ballasts) with phase shifting capacitors. Fluorescent lamps with electronic controllers or without phase shifting capacitors can be used, depending on the operating limits specified for each type of relay.

Refer to *UL508A Supplement SB and Seifert Systems' document [Short Circuit Current Rating \(SCCR\)](#) on methods how to modify the available short circuit current within a circuit in the panel.*

SCCR



Refer to *UL508A Supplement SB and Seifert Systems' document [Short Circuit Current Rating \(SCCR\)](#) on methods how to modify the available short circuit current within a circuit in the panel.*

14. Controller

The display shows the temperature in the range of -50°C to +150°C (-58°F to +302°F). The temperature is displayed with resolution of tenths between -19.9°C and +99.9°C (-3.8°F to +211.8°F). During programming, it shows the codes and values of the parameters. The display also shows icons according to occurring events.



Display icons

Icon	Function	Description
1	Compressor relay active	Flashes when activation is delayed or inhibited by protection times, external disabling or other procedures in progress
2	Alarm relay active	
3	Heater relay active	
4	Ambient blower relay active	
	Alarm	Flashes when alarms are active
	Heating mode	Signals operation of unit in heating mode
	Cooling mode	Signals operation of unit in cooling mode
TEST	Test mode in progress	Activated only by manual procedure

Programming

The operating parameters can be modified using the front keypad. Access differs depending on the type of parameter. Access to configuration parameters is protected by a password that prevents unwanted modifications or access by unauthorised persons.

Setting cooling set point, St1:



1. Press "SET" and display should show St1 and then the pre-set value of St1. (default: +35°C / +95°F)
2. Reach the desired value by using ▲ or ▼.
3. Press "SET" again to save the new value of St1.

Setting heating set point, St2 (only for units supplied with internal heater):



1. Press "SET" twice slowly and display should show St2 and then the pre-set value of St2. (default: +5°C / +41°F)
2. Reach the desired value by using ▲ or ▼.
3. Press "SET" again to save the new value of St2.

Setting temperature units (°C / °F), low temperature alarm and high temperature alarm:



1. Press "PRG" button for 5 seconds to reach the modifiable parameter list.
2. Use ▲ or ▼ to reach the desired parameter:
 - C18 for temperature unit of measure
 - °C = 0
 - °F = 1
 - P25 for low temperature alarm threshold (default -10°C / +14°F)
 - P26 for high temperature alarm threshold (default +55°C / +131°F)
 - c68 for door contact NO/NC logic change (0=ON if closed, 1=ON if open)
Controller firmware rev. 1.2 or higher.
3. Press "SET" on the desired parameter to display the current value.
4. Use ▲ or ▼ to reach the desired value.
5. Pressing "SET" temporarily saves the new value and returns to the parameters list.
6. Repeat steps 2-5 to set other parameters.
7. Press "PRG" for 5 seconds to permanently save the new values.







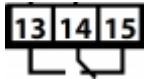

Test function

Different test functions can be used depending on the combination of keys pressed. Such tests run for the duration of 4 minutes.

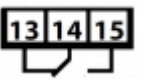
- "SET+▲" tests Compressor and Ambient Blower relays.
- "SET+▼" tests Alarms and Heater relays

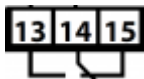
Alarm Relay Operation

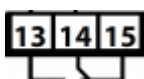
Both normally closed (NC) and normally open (NO) alarm contacts are provided. These refer to the alarm state. Under normal conditions, the NC contact is closed and the NO contact is open. When an alarm condition is present or the door contact is open, the NC contact will open and the NO contact will close. System power failure will give an alarm condition.

State	Alarm relay	Display
1 System powered OFF		
2 System powered ON - NO ALARM - Door Contact Closed		
3 System powered ON - Door Contact Open		
4 System powered ON - ALARM STATE		

Failure table:

The display shows either "OFF" or "EXX" with an icon flashing (triangle), alternating with the standard display. If more than one error occurs, these are shown in sequence on the display.



Failure Code	Description	Solution
OFF	Door open	Close the enclosure door and check the door contact switch. If no door contact switch is used and c68=0, bridge terminals on power connector.
	Incorrect phase sequence (3-phase units)	Displayed on power-up. Check phase sequence.
E01	Failure internal temperature sensor	Check probe connections
E02	Failure ambient temperature sensor	Check probe connections
E04	High temperature alarm	The measured temperature has exceeded the threshold P26. Check rating of the cooling unit. Clean air filters, condenser; check fans' and compressor's correct operation. Contact your service partner.
E05	Low temperature alarm	The measured temperature has fallen below the threshold P25.

Failure Code	Description	Solution
E07 / E08	Controller error	Contact your service partner.

Important Notes

- Whilst programming, if no button is pressed for 10 seconds, the display starts flashing, and after 1 minute returns to the main display without saving changes.
- To increase scrolling speed, press and hold the ▲ or ▼ button for at least 5 seconds.
- When pressing “PRG” for 3 seconds, the firmware revision code is displayed for 2 seconds.
- When cleaning the controller panel, do not use ethanol, hydrocarbons, ammonia or their by-products. Use neutral detergents and water.
- In order to protect the unit’s components, minimum relay output on (3 or 7 minutes) and off (4 minutes) times and minimum time (7 or 11 minutes) between activation of the same relay output are applied.
- In case of digital inputs not configured, probes not fitted or configured, or St2 not enabled on the controller the display shows ‘nO’.

15. Wiring diagram

Power Cable (AWG18)

BK	L1
BU	N
GNYE	PE

Signals Cable (AWG20)

GY	Alarm (NC)
BN	Alarm (COM)
BU	Alarm (NO)
RD	Door contact
PK	Door contact

PART LIST

Sa: Ambient Temperature Sensor (Optional)
Si: Internal Temperature Sensor
Hcc: Compressor c/case heater (Optional)
Hce: Condensate evaporator heater
Hi: Internal heater
Cc: Compressor capacitor
Ps: DC Power Supply
Mc: Compressor
Ma: Ambient fan
Mi: Internal fan

NOTES

See Unit typeplate for correct operating voltage and frequency.
 Suitable protective devices should be installed on the supply line.
 Use copper conductors only.
 Use supply wires suitable for 75°C (167 °F).

1. Connected for units with internal heater. (Optional)

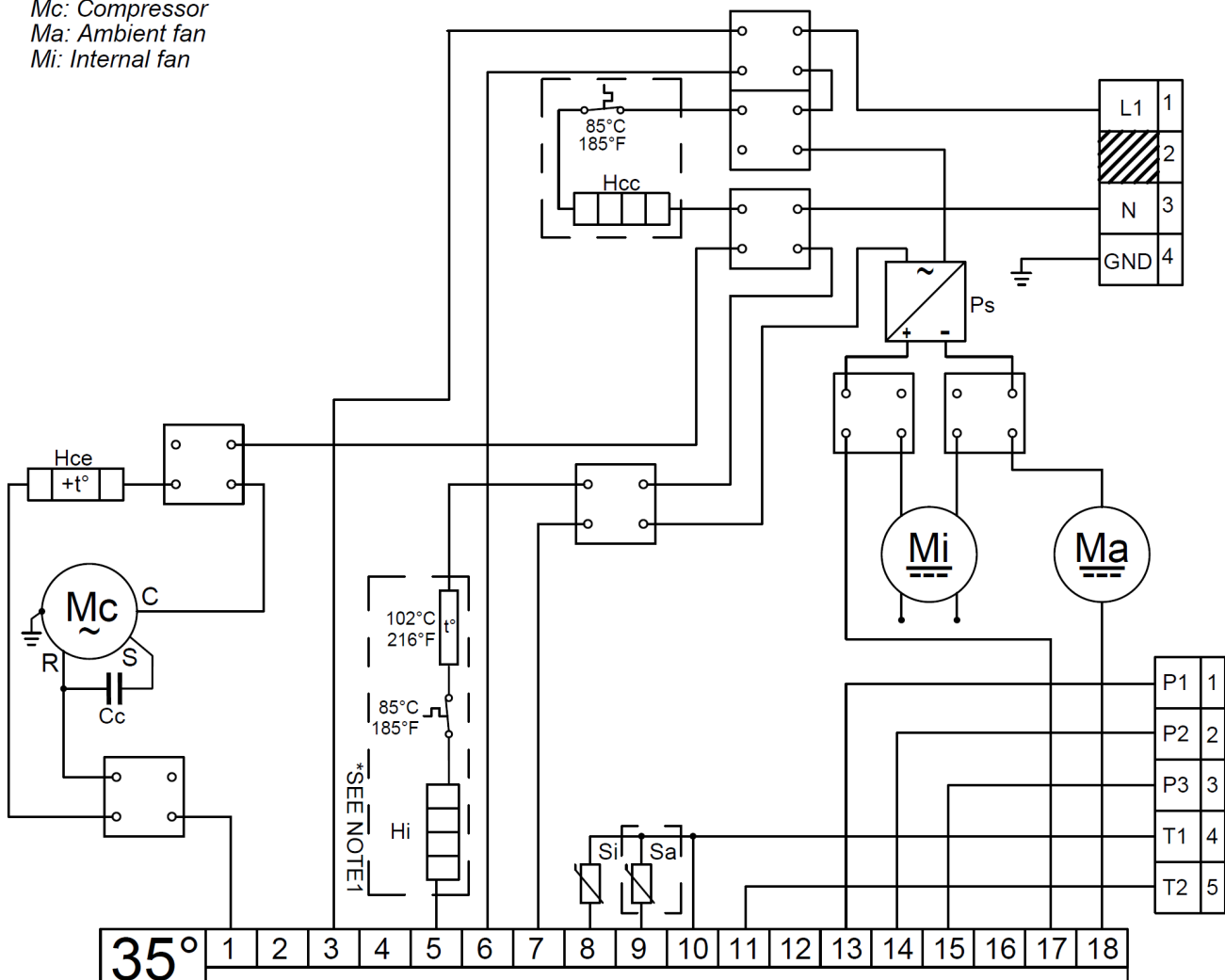

PR596030640/c

16. Taking into operation

Attention!

The unit can be damaged by lack of lubricant. To ensure that the compressor is adequately lubricated the oil, which has been displaced during transport, must be allowed to flow back into it. The unit must therefore be allowed to stand for at least 30 min. before being connected to the mains and taken into operation.

The unit / system must be protected with a MCB Type D or K. Upon connection the internal fan will start working. If the temperature inside the enclosure is higher than the set value of the controller both the compressor and external air fan start working. The cooling cycle will either stop once the air inside the enclosure reaches the set temperature minus hysteresis or once the minimum On-time is reached. The setpoint for the internal enclosure temperature is pre-set at 95°F.

The hysteresis is 3K, the minimum ON-time is 4 minutes, the minimum OFF-time is 3 minutes, for units with a cooling capacity of more than 1 kW is it usually 7 minutes.

17. Trouble shooting

Failure	Condition	Cause	Solution
Unit doesn't cool	Internal fan does not work	Power not connected.	Verify power supply
	Internal fan works, external fan and compressor don't work	Enclosure temperature is below setting temperature (St)	Verify values of parameter "St"
		Door switch contact is open	Verify door switch
		Controller doesn't work	Replace controller
Internal fan works, external fan and compressor don't work. Display shows alternating OFF and temperature	The sequence of the phases inside the power supply connector is incorrect	Change phases inside power supply connector	
Unit doesn't cool	External and internal fan work, compressor does not work	Compressor motor electrical failure	Have compressor replaced by qualified service technician
		Capacitor for compressor failed	Replace capacitor
	Compressor works, external fan doesn't work	External fan needs to be replaced	Replace external fan
Enclosure temperature too hot	Compressor and fans (external and internal) work all the time	Cooling unit undersized	Enclosure needs a cooling unit with higher capacity
		Thermal compressor protector triggered	Verify if ambient temperature is too high, clean condenser
	Compressor and external fan work in alternating mode (ON / OFF)	Refrigerant leakage	Contact dealer/service center
Excessive condensate	Enclosure door open	Ambient air gets into the enclosure	Ensure door is closed, add a door switch and connect it to controller
	Enclosure door closed	Enclosure IP protection class is below IP54	Seal all openings of the enclosure
		Damaged or misplaced sealing strip	Repair sealing strip accordingly

18. Maintenance & Cleaning



*Always switch power supply off before starting any maintenance on the unit.
Wait for 5 minutes for electrical components to discharge.*

The cooling unit is generally maintenance free and can be operated without filters in most environments.

If the ambient air is extremely dusty, we recommend installing filter mats (see accessories). These should be cleaned or replaced at regular intervals. Oily or greasy filter mats should be replaced immediately. Do not use a steam jet or high pressure to clean the filter mats. Do not wring out the filter mats. If the ambient air is extremely oily, we recommend the use of metal filters (see accessories). They can be cleaned with standard cleaning agents and reused. In addition the unit should have regular functional tests (approx. every 2,000 hours depending on the grade of ambient pollution).

Note: The use of filter mats / metal filters reduces the cooling capacity of the unit..

Disposal

The cooling unit contains R134a refrigerant and small quantities of lubricating oil. Replacement, repairs and final disposal must be done according to the regulations of each country for these substances.

19. Transport & Storage

Malfunction due to transport damage

On delivery the carton box containing the unit must be examined for signs of transport damage. Any transport damage to the carton box could indicate that the unit itself has been damaged in transit which in the worst case could mean that the unit will not function.

The unit can only be stored in locations which meet the following conditions:



- temperature range: - 40°F to 158°F
- relative humidity (at 77°F): max. 95 %
- the air conditioner should always be stored according to the installation position

Returning the unit

To avoid transport damage the unit should be returned in the original packing or in a packing case and must be strapped to a pallet. If the unit cannot be returned in the original packing please ensure that:

- A space of at least 30 mm. must be maintained at all points between the unit and the external packing.
- The unit must be shipped in the same position as it was mounted.
- The unit must be protected by shock resistant padding (hard foam corner pieces, strips or cardboard corner pieces).

20. Parts supplied / Spare parts / Accessories

Description	QTY	Image
Instruction manual	1	
CE Declaration	1	
Mounting template	1	
M6 * 16 bolts	6	
A6.4 toothed washers	6	
A6.4 washers	6	

Seifert Systems Inc.
75 Circuit Drive, North Kingstown
RI 02852, United States

Tel. 401-294-6960